

Hand Operated Curtain Track Systems





Hand Operated Curtain Track System

Silent Gliss® 6840

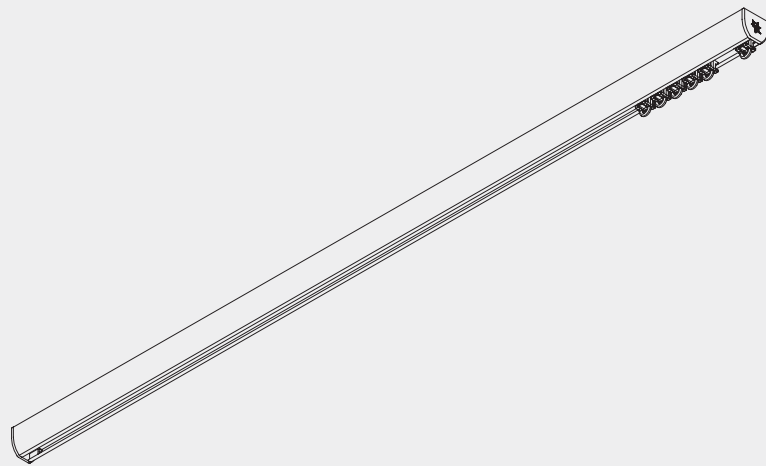

Product Information

- Operation: hand drawn
- Range: M
- Fitting: ceiling, wall
- Colours: white, matt white, silver anodised, anodic grey, charcoal and antique bronze
- Shape: oval
- 2C glider technology
- Wave compatible
- Bendable



6840

Profile and Bending Information

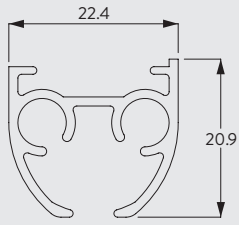

3841

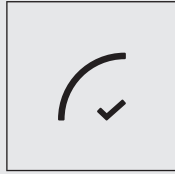

Radius: 20 cm, >30 cm
Radius with Wave: >25 cm

Specification Guide- download from www.silentgliss.co.uk (password required).

Silent Gliss 6840 aluminium curtain track, hand drawn, powder coated in white/matt white/ anodic grey/anodic grey/charcoal and silver anodised. Supplied as standard with 2C gliders 11301 at 14/m, 2 endcovers 3842 and 2 endstops 6065. Top fixed with special fixing clamp 3825 at 500 mm centres. Optional top fix bracket 3826 / face fix with Smartfix brackets. Silent Gliss Wave option is available using 60mm glider cord 11303 / 80mm glider cord 11302.

How To Measure

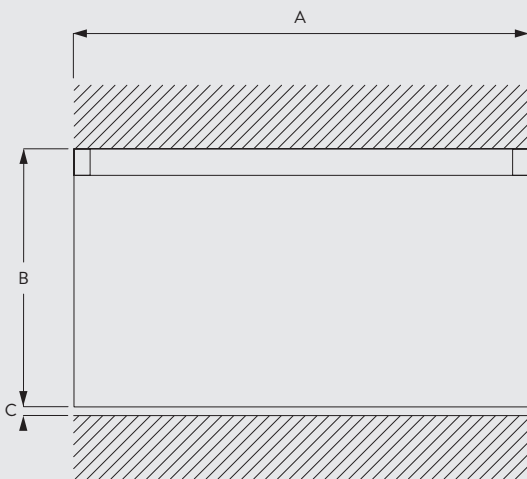

A: System width
B: System height
C: Distance between floor and fabric

6840

System Options

Wave Curtain Heading System

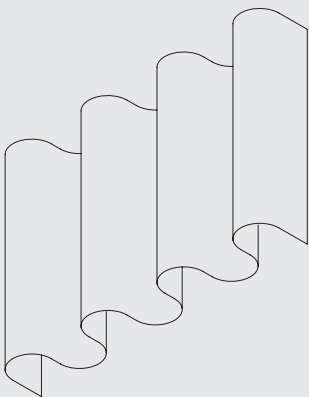

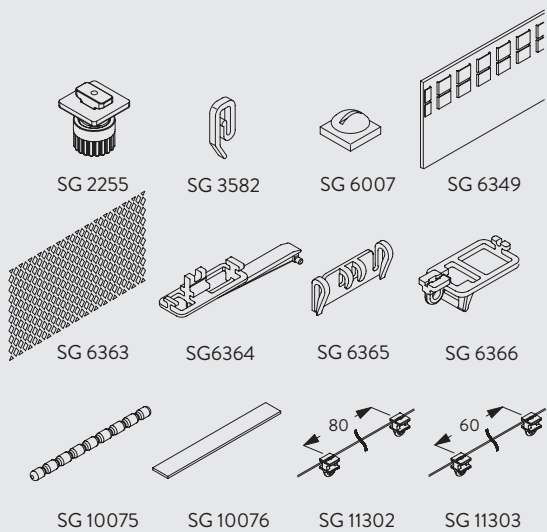

The Wave standard components are:

- 11303 Wave 2C Glider Cord 60mm
- 11302 Wave 2C Glider Cord 80mm
- 6007 End stop
- 6315 Pilot runner

The items listed below for Enhanced Wave (80mm glider cord only) are all supplied at an additional cost as per the price list.

- 2255 Adjustable brake
- 6364 Extension (used with 6365)
- 6365 Hanger (used with 6364)
- 6366 Carrier for draw rod

Roller Gliders must be ordered separately
6099 Wave roller glider 80mm

Optional components to improve the presentation of the curtain:

- 3582 Hook
- 6349 Curtain tape
- 6363 Iron-on top hemming tape
- 10075 Lead weight for hem of curtain 50gr/m
- 10076 Fabric weight for side edge of curtain

Fitting Information

Fixing Points

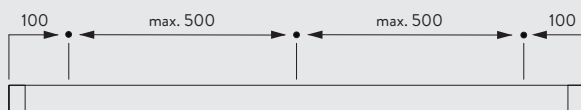

Fitting Options

Ceiling fitting with clamp SG 3825

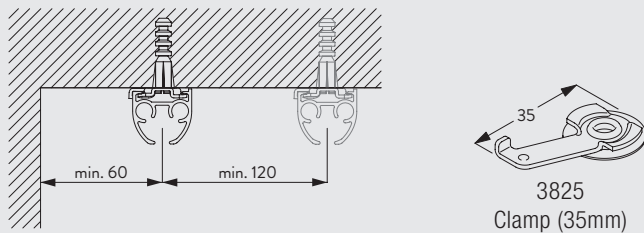

Ceiling fitting with bracket SG 3826

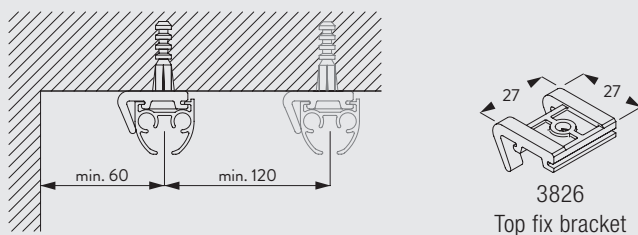

Ceiling fitting with bracket SG 3832

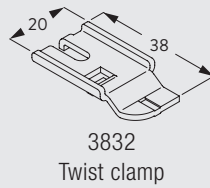
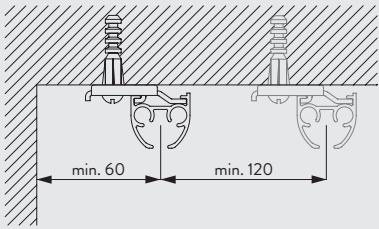

Wall fitting with Smart Fix SG 11200-11205 and bracket SG 3826

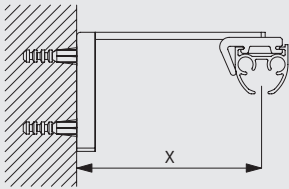

	X (mm)
11200	52
11201	72
11202	92
11203	112
11204	142
11205	192

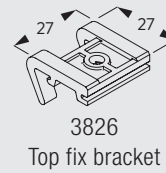
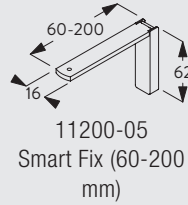

Brackets threaded for screw M4 x 8

Wall fitting with Square Smart Fix SG 11210-11215 and bracket SG 3826

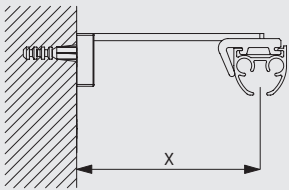

	X (mm)
11210	52
11211	72
11212	92
11213	112
11214	142
11215	192

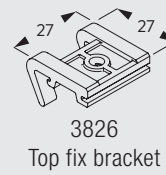
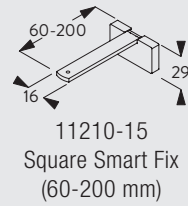

Brackets threaded for screw M4 x 8

Wall fitting with Universal Smart Fix SG 11154-11156 and bracket SG 3826

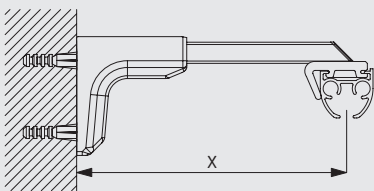

	X (mm)
11154	102-130
11155	132-160
11156	182-210

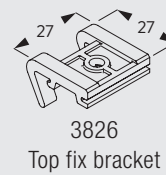
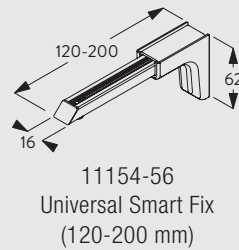

Brackets threaded for screw M4 x 8

Wall fitting with Smart Fix SG 11200-11205 and bracket SG 3832

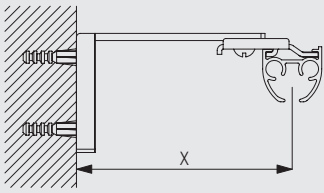

	X (mm)
11200	70
11201	90
11202	110
11203	130
11204	160
11205	210

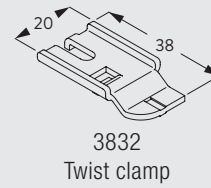
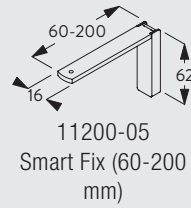

Brackets threaded for screw M4 x 8

Wall fitting with Square Smart Fix SG 11210-11215 and bracket SG 3832

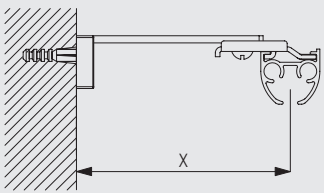

	X (mm)
11210	70
11211	90
11212	110
11213	130
11214	160
11215	210

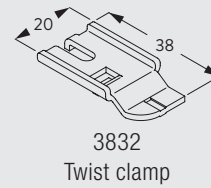
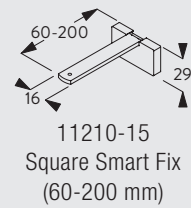

Brackets threaded for screw M4 x 8

Wall fitting with Universal Smart Fix SG 11154-11156 and bracket SG 3832

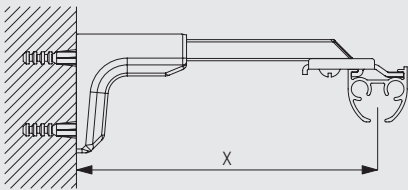

	X (mm)
11154	120-148
11155	150-178
11156	200-228

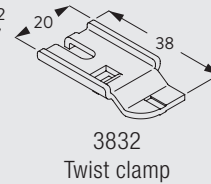
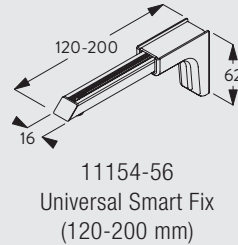

Brackets threaded for screw M4 x 8

Wall fitting with bracket SG 3836

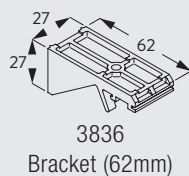
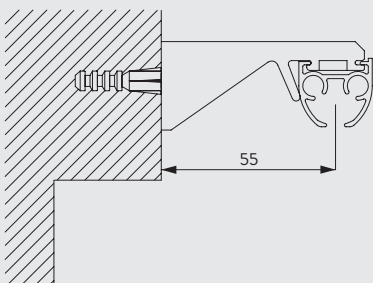

Standard Accessories

3825 Clamp (35mm)



3841 Profile





3842 End cover 

6065 Twist eye endstop 

11301 2C glider 11300 on strip (x20) 

Optional Accessories

3582 Hook 

3599 Hook 

3802 Connecting bridge 

3826 Top fix bracket 

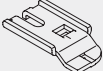
3832 Twist clamp 

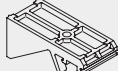
3836 Bracket (62mm) 

6007 Endstop 

6053 Spring stop 

6064 Screw twist endstop 

6086 Spring stop 

6094 Roller glider with hook 

6098 Roller glider with eye 

6283 Roller glider 

10430 Draw rod with hook, 50cm 

10431 Draw rod with hook, 75cm 

10432 Draw rod with hook, 100cm 

10433 Draw rod with hook, 125cm 

10434 Draw rod with hook, 150cm 

11154 Universal Smart Fix, 120 mm set 

11155 Universal Smart Fix, 150 mm set 

11156 Universal Smart Fix, 200 mm set 

11200 Smart Fix, 60 mm set 

11201 Smart Fix, 80 mm set 

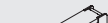
11202 Smart Fix, 100 mm set 

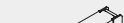
11203 Smart Fix, 120 mm set 

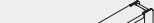
11204 Smart Fix, 150 mm set 

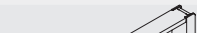
11205 Smart Fix, 200 mm set 

11210 Square Smart Fix, 60 mm set 

11211 Square Smart Fix, 80 mm set

11212 Square Smart Fix, 100 mm set

11213 Square Smart Fix, 120 mm set

11214 Square Smart Fix, 150 mm set

6840

11215 Square Smart Fix, 200 mm set

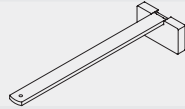

Wave Accessories

2255 Adjustable brake



6349 Curtain tape



6364 Extension

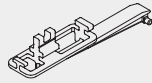

6366 Wave carrier for draw rod

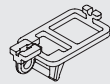

10076 Fabric weight



11303 Wave 2C glider cord 60 mm



6099 Wave roller glider cord (80mm)



6363 Top hemming tape



6365 Hanger

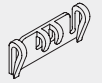

10075 Lead weight 50 gr/m

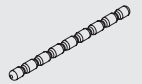

11302 Wave 2C glider cord 80 mm

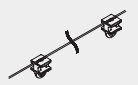

6840