

Hand Operated Curtain Track Systems





Hand Operated Curtain Track System

Silent Gliss® 6970

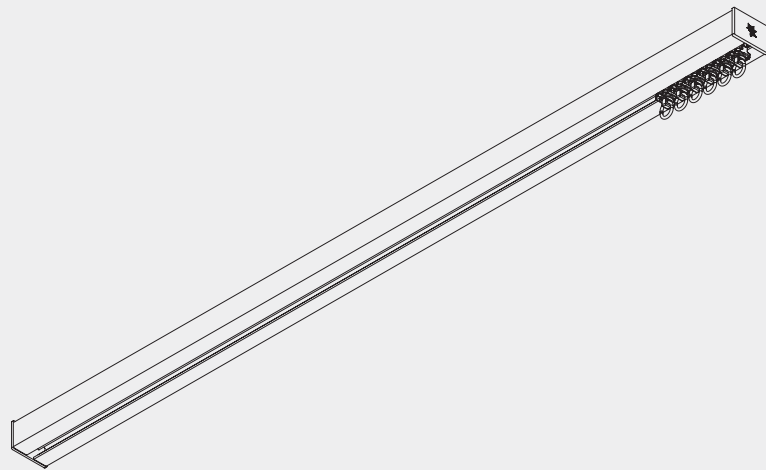

Product Information

- Operation: hand drawn
- Range: L
- Fitting: ceiling, wall, recess
- Colours: white
- Shape: square
- 2C glider technology
- Wave compatible
- Bendable (including recess profile)



6970

Profile and Bending Information

Profile

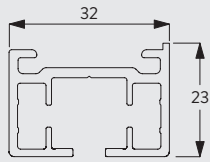

10850



Radius: >25 cm

Recess profile

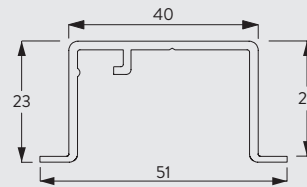

10862

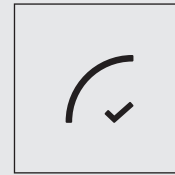

Radius: >50 cm
Max. radius: 75 cm

Specification text:

Silent Gliss SG 6970 Hand Operated Curtain Track System. Comprises aluminium profile SG 10850 supplied made to measure available in silver anodised or powder coated in white. Supplied as standard with 2C roller gliders SG 10840 at 10/m, 2 end covers SG 11235 and 2 end stops SG 6007. Top fixed with fixing clamp SG 3004 at max. 500mm centres. Optional top fix with SG 3041 bracket or direct top fix with mounting plate SG 10865 and profile protector SG 7002. Wall fix with SG Smart Fix brackets SG 11201-11205 and SG 3041 or SG 3004 / SG Square Smart Fix brackets SG 11210-11215 and SG 3041 or SG 3004 / SG Universal Smart Fix brackets SG 11154-11156 and SG 3041 or SG 3004. Recess fix with recess profile SG 10862, recess masks SG 10864 and wedges SG 5118. Silent Gliss Wave option is available using 60mm glider cord 10869 / 80mm glider cord SG 10852.

How To Measure

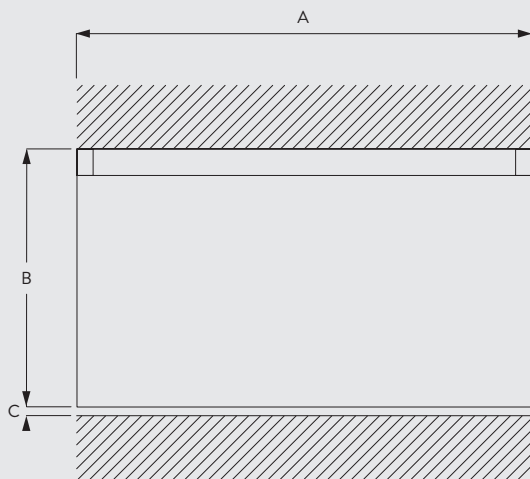

A: System width
B: System height
C: Distance between floor and fabric

System Options

Wave Curtain Heading System

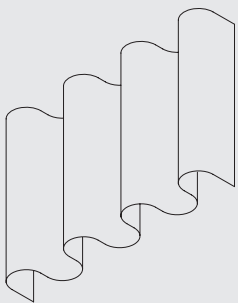

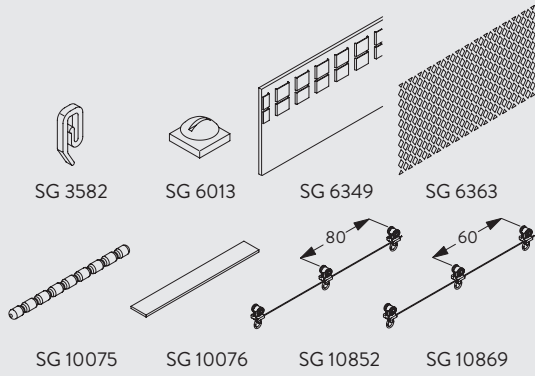

The Wave standard components are:

- 10869 Wave 2C Glider Cord 60mm
- 10852 Wave 2C Glider Cord 80mm
- 6007 End stop

Optional components to improve the presentation of the curtain:

- 3582 Hook
- 6349 Curtain tape
- 6363 Iron-on top hemming tape
- 10075 Lead weight for hem of curtain 50gr/m
- 10076 Fabric weight for side edge of curtain

Fitting Information

Fixing Points

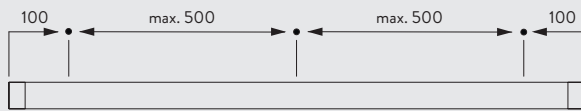

Fitting Options

Ceiling fitting with direct mounting

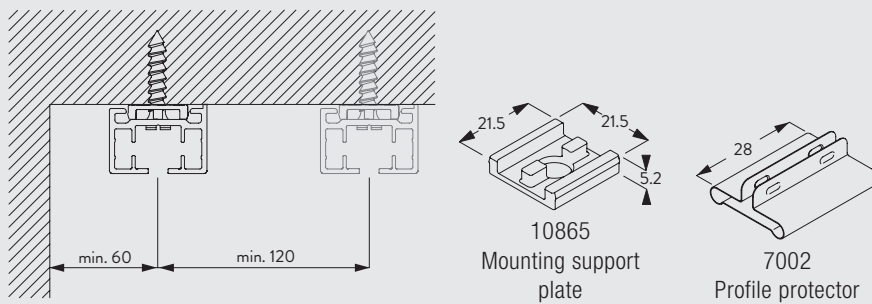

Ceiling fitting with clamp SG 3004

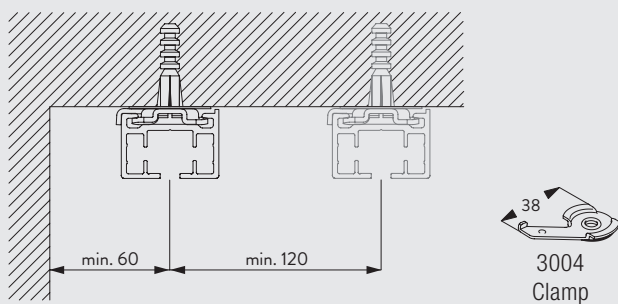

6970

Wall fitting with Smart Fix SG 11200-11205 and bracket SG 3041

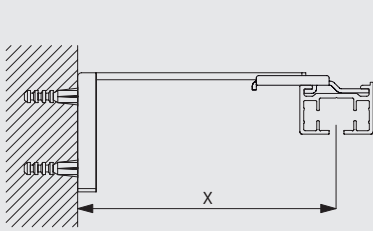

	X (mm)
11200	83
11201	103
11202	123
11203	143
11204	173
11205	223

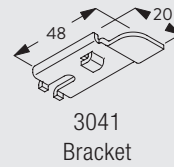
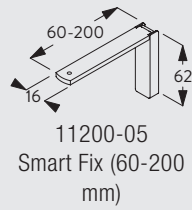

Brackets threaded for screw M4 x 8

Wall fitting with Square Smart Fix SG 11210-11215 and bracket SG 3041

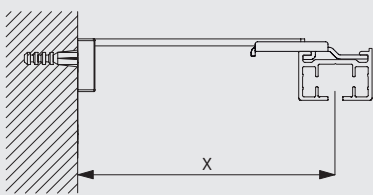

	X (mm)
11210	83
11211	103
11212	123
11213	143
11214	173
11215	223

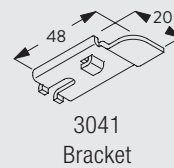
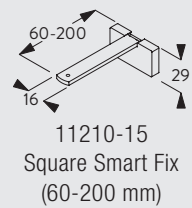

Brackets threaded for screw M4 x 8

Wall fitting with Universal Smart Fix SG 11154-11156 and bracket SG 3041

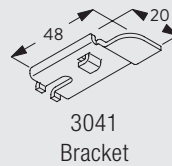
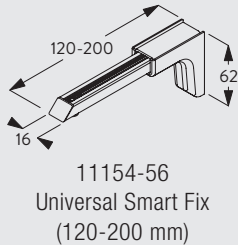
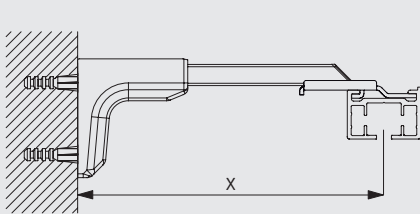

Brackets threaded for screw M4 x 8

Wall fitting with Smart Fix SG 11201-11205 and clamp SG 3004

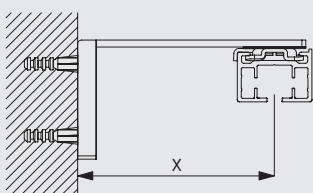

	X (mm)
11201	72
11202	92
11203	112
11204	142
11205	192

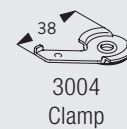
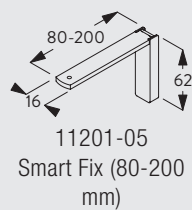

Brackets threaded for screw M4 x 8

Wall fitting with Square Smart Fix SG 11211-11215 and clamp SG 3004

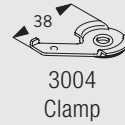
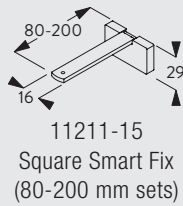
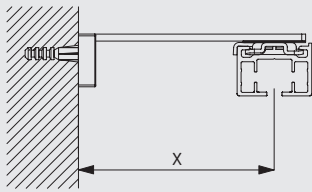

Brackets threaded for screw M4 x 8

Wall fitting with Universal Smart Fix SG 11154-11156 and clamp SG 3004

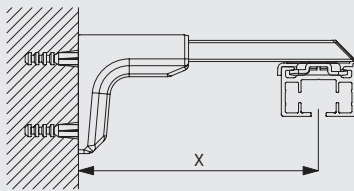

	X (mm)
11154	102-130
11155	132-160
11156	182-210

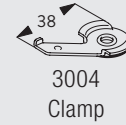
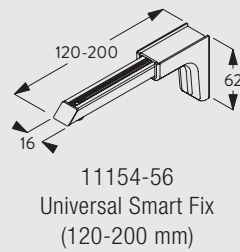

Brackets threaded for screw M4 x 8

Recess fitting with recess profile SG 10862

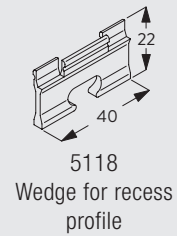
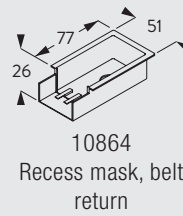
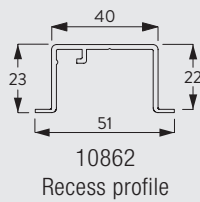
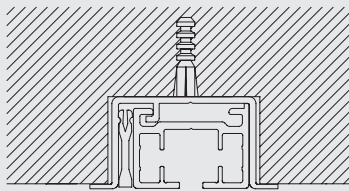

6970

Standard Accessories

3004 Clamp



6007 Endstop



10840 Two component roller



10850 Profile

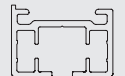

11235 End cover



Optional Accessories

3582 Hook



5118 Wedge for recess profile









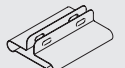





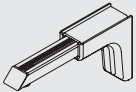
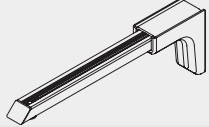

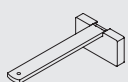
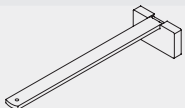

6007 Endstop



7002 Profile protector

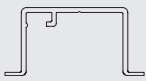
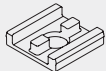
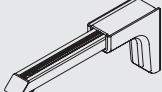

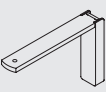
10407	Pan head screw M4x10	
10431	Draw rod with hook, 75cm	
10433	Draw rod with hook, 125cm	
10831	Connecting bridge	
10864	Recess mask, belt return	
11154	Universal Smart Fix, 120 mm set	
11156	Universal Smart Fix, 200 mm set	
11201	Smart Fix, 80 mm set	
11203	Smart Fix, 120 mm set	
11205	Smart Fix, 200 mm set	
11211	Square Smart Fix, 80 mm set	
11213	Square Smart Fix, 120 mm set	
11215	Square Smart Fix, 200 mm set	

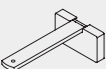
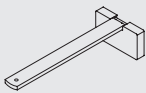
10430	Draw rod with hook, 50cm	
10432	Draw rod with hook, 100cm	
10434	Draw rod with hook, 150cm	
10862	Recess profile	
10865	Mounting support plate	
11155	Universal Smart Fix, 150 mm set	
11200	Smart Fix, 60 mm set	
11202	Smart Fix, 100 mm set	
11204	Smart Fix, 150 mm set	
11210	Square Smart Fix, 60 mm set	
11212	Square Smart Fix, 100 mm set	
11214	Square Smart Fix, 150 mm set	

6970

Wave Accessories

6349	Curtain tape	
10075	Lead weight 50 gr/m	
10852	Wave roller cord (80mm), 6.5mm channel	

6363	Top hemming tape	
10076	Fabric weight	
10869	Wave roller cord (60mm), 6.5mm channel	